

1:Fix the hanging board to the ceiling

2:Connect the lamp wires to the reserved wires

3:Tighten the nut to secure the lamp body

4:Installing bulb

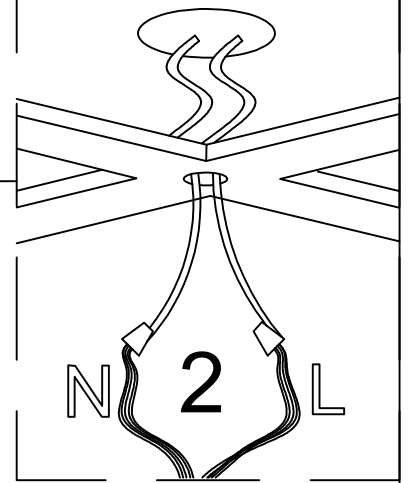
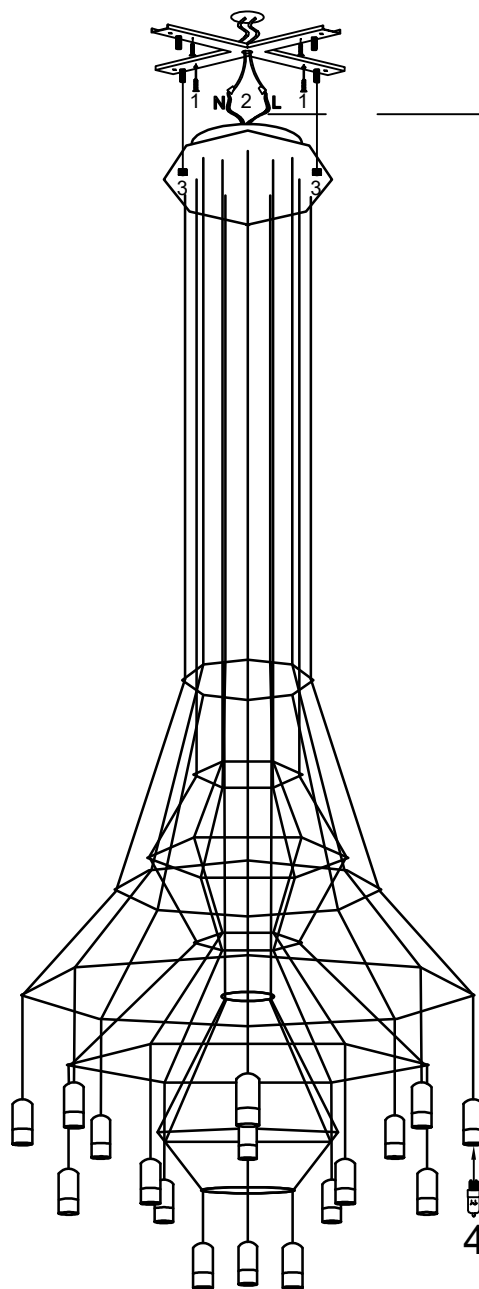

Wiring instructions

1: Fix the hanging board to the ceiling

2: Connect the lamp wires to the reserved wires

3: Tighten the nut to secure the lamp body

4: Installing bulb

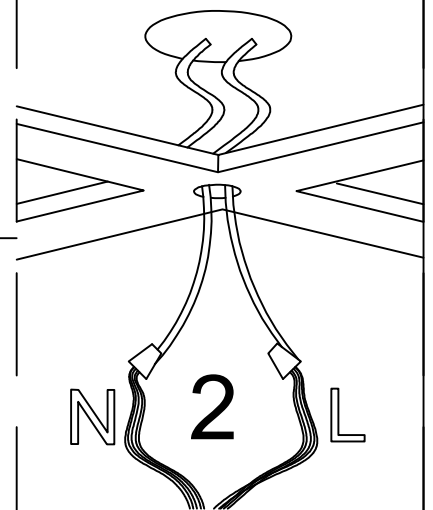
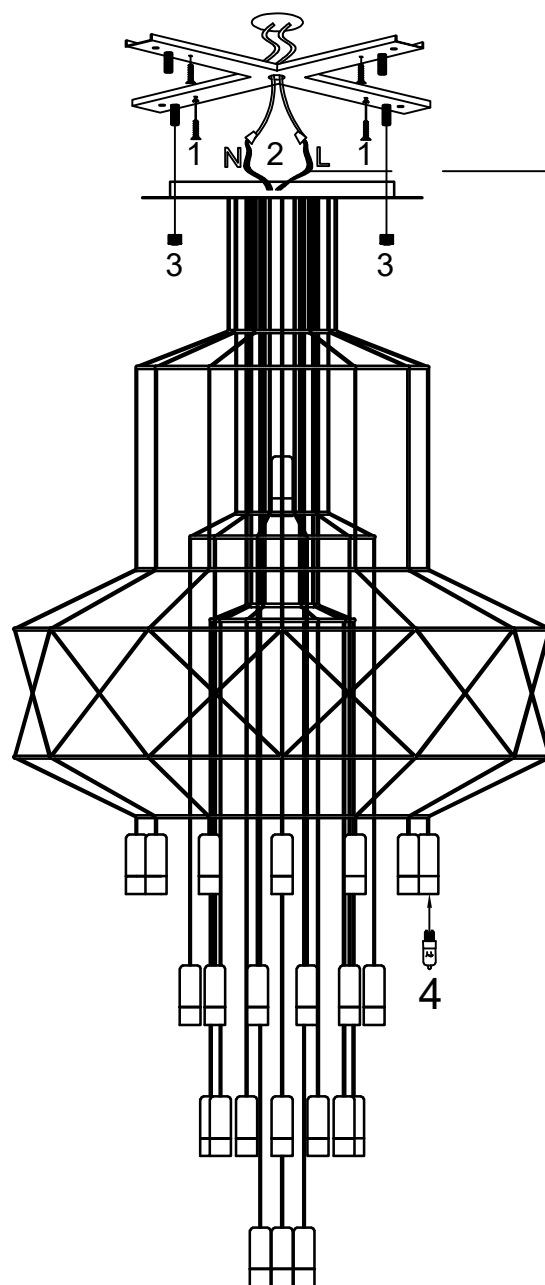

Wiring instructions

1: Fix the hanging board to the ceiling

2: Connect the lamp wires to the reserved wires

3: Tighten the nut to secure the lamp body

4: Installing bulb

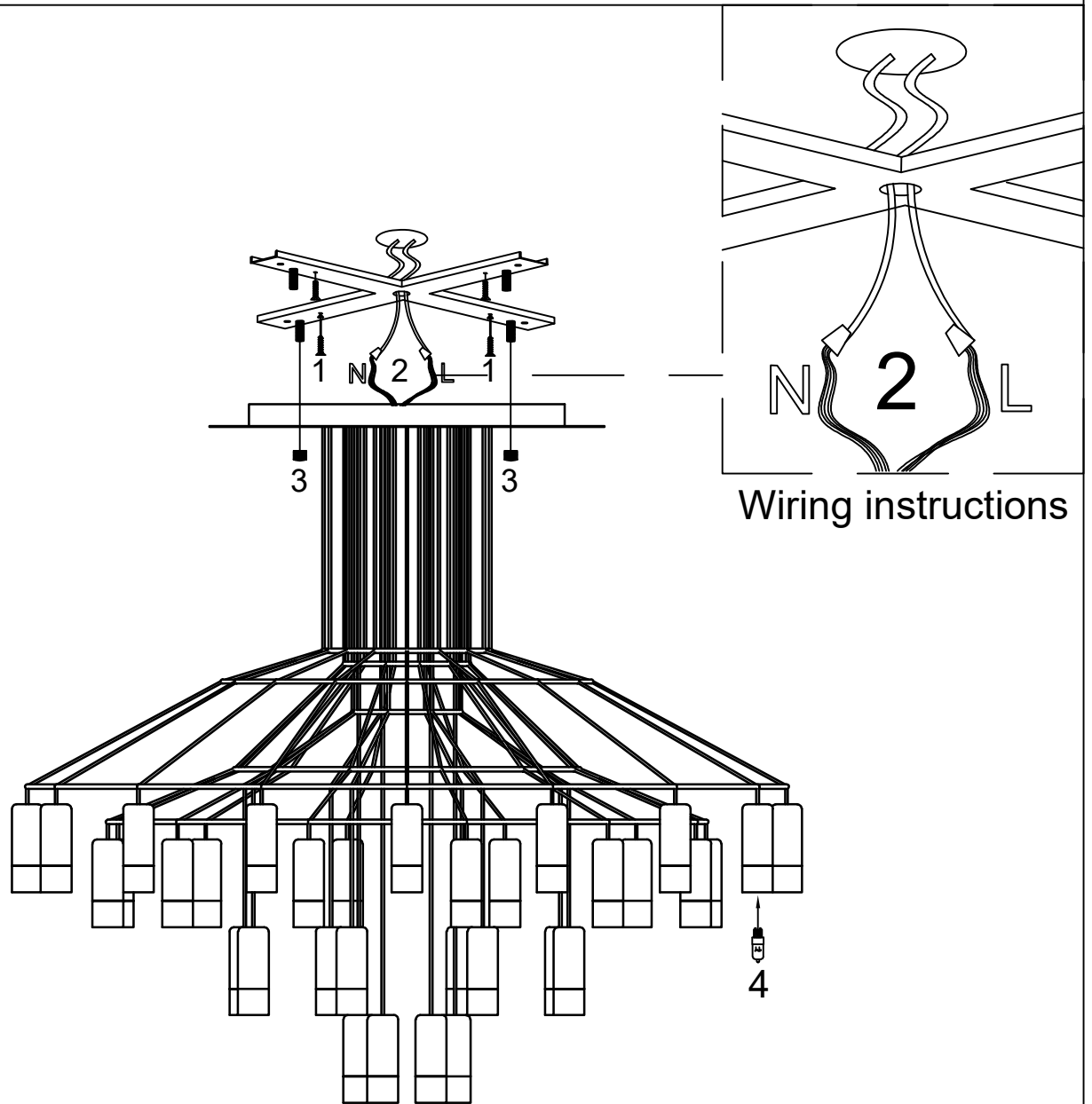

1: Fix the hanging board to the ceiling

2: Connect the lamp wires to the reserved wires

3: Tighten the nut to secure the lamp body

4: Installing bulb

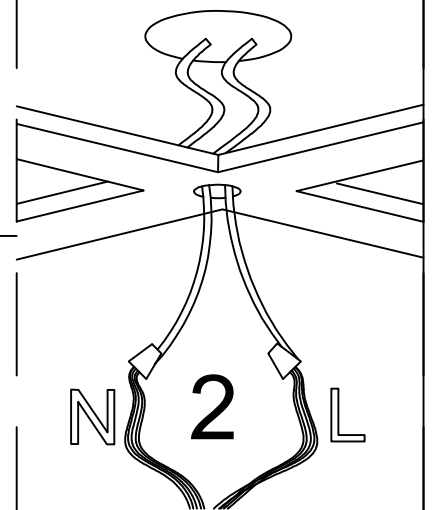
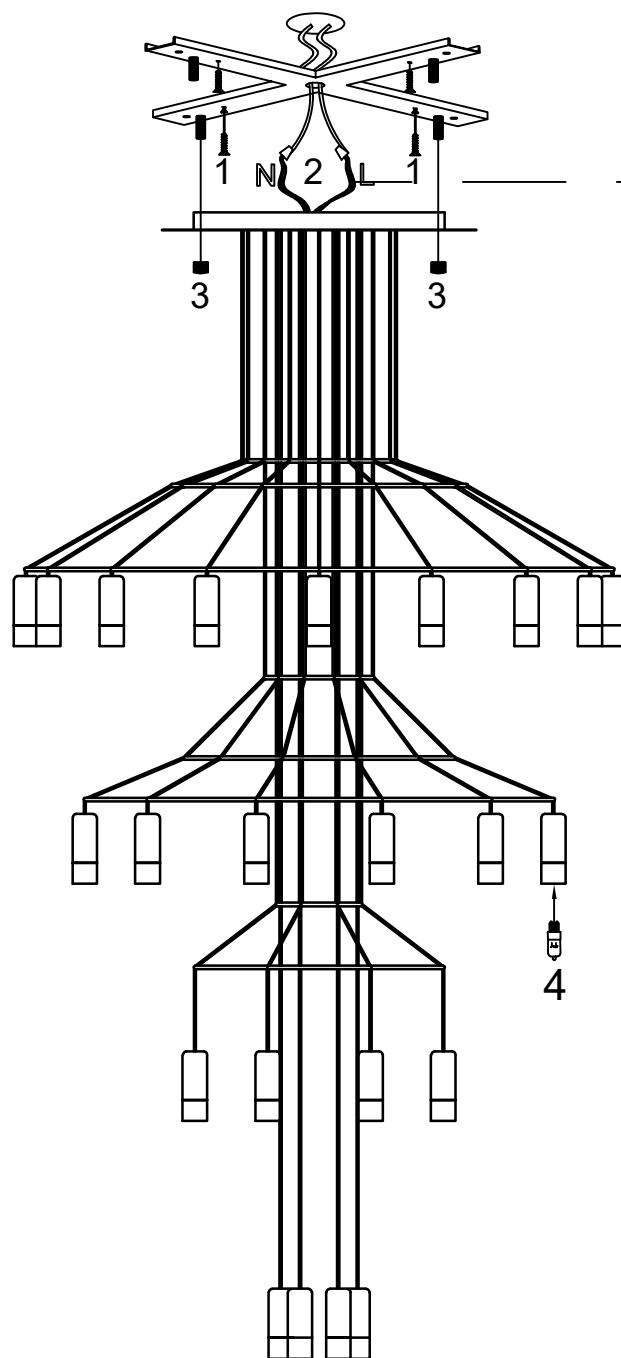

Wiring instructions

1: Fix the hanging board to the ceiling

2: Connect the lamp wires to the reserved wires

3: Tighten the nut to secure the lamp body

4: Installing bulb

