

1

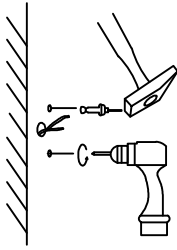

Drill holes in the wall and insert expansion screws

2

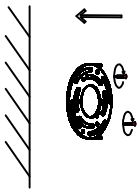

Install the hanging plate on the wall

3



The electric wires in the home connect to the light fixtures

4

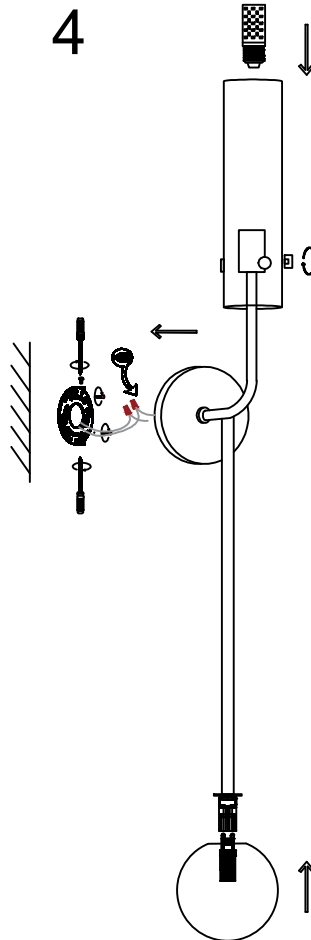

Install the lamp body on the hanging plate

Install bulb and lampshade

1

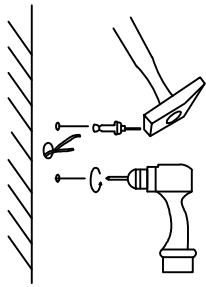

Drill holes in the wall and
insert expansion screws

2

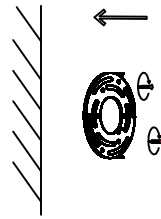

Install the hanging plate on
the wall

3

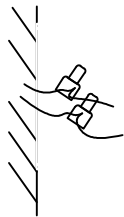

The electric wires in the home
connect to the light fixtures

4

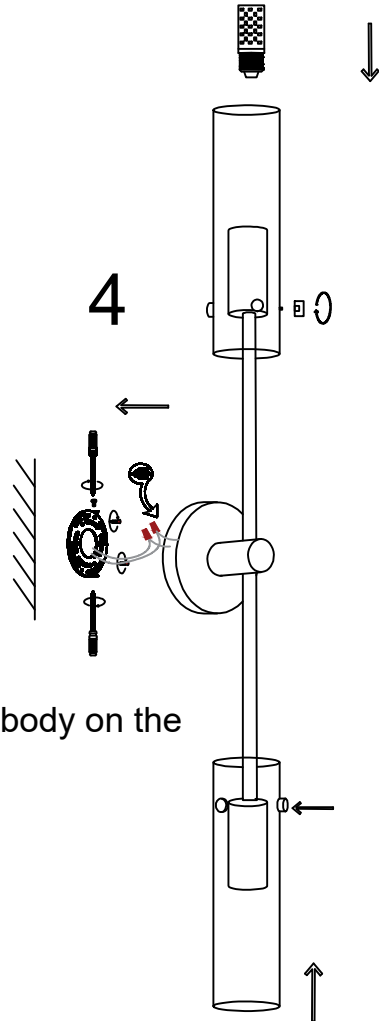

Install the lamp body on the
hanging plate

Install bulbs and lampshades

1

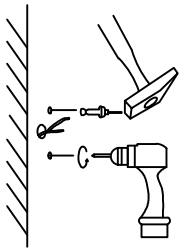

Drill holes in the wall and insert expansion screws

2

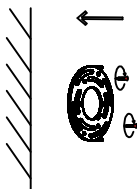

Install the hanging plate on the wall

3

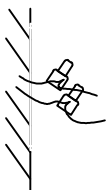

The electric wires in the home connect to the light fixtures

4

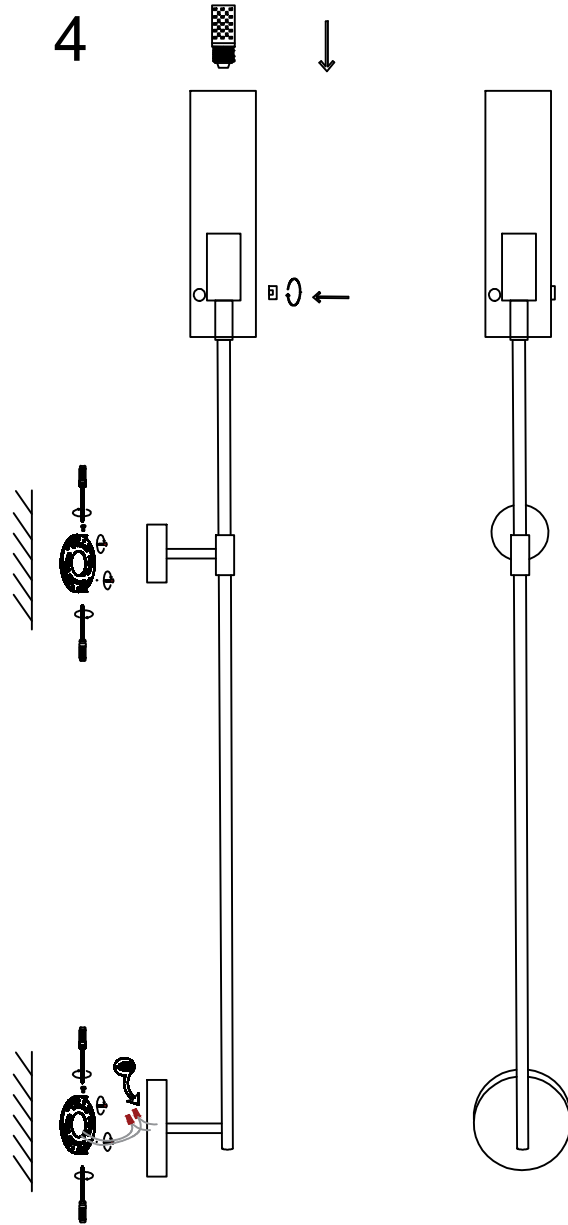

Install the lamp body on the hanging plate

Install bulb and lampshade

1

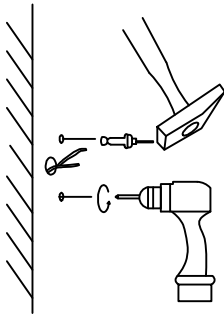

Drill holes in the wall and insert expansion screws

2

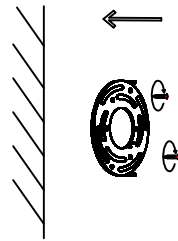

Install the hanging plate on the wall

3

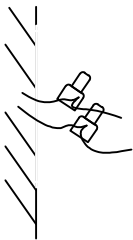

The electric wires in the home connect to the light fixtures

4

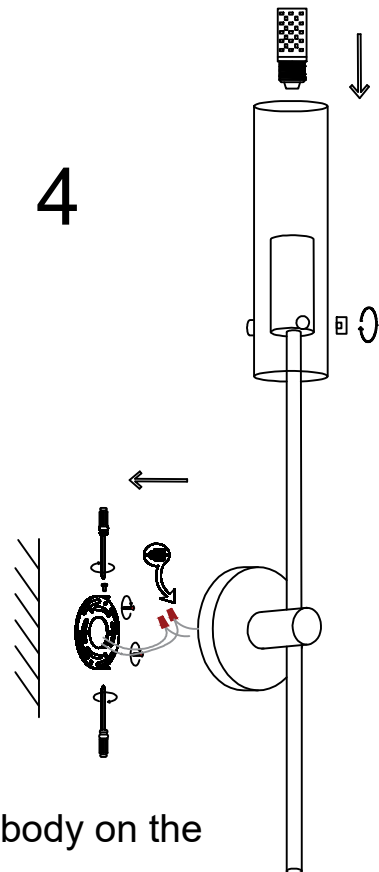

Install the lamp body on the hanging plate

Install bulb and lampshade