

1

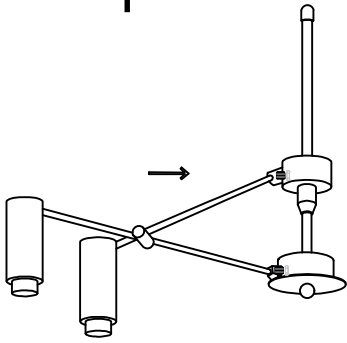

The lamp arm is connected to the center post by screws

2

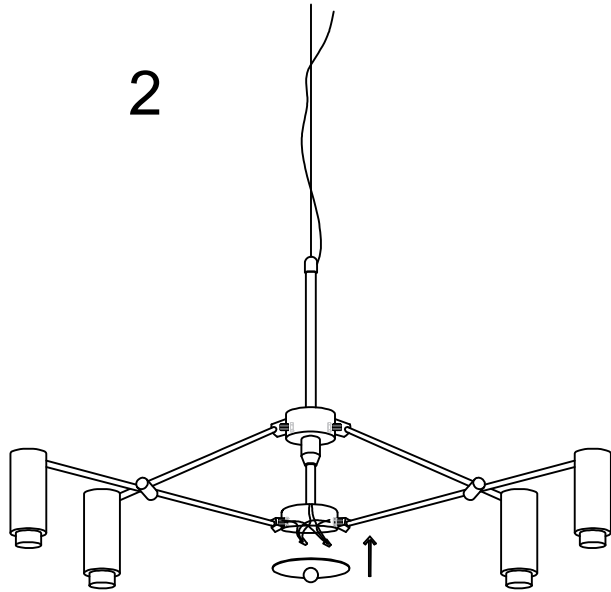

The lamp arm wire is connected to the main line (Lines of the same color are joined together)

3

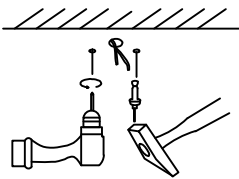

Drill holes in the ceiling and insert expansion screws

5

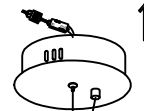
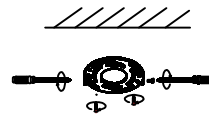

4

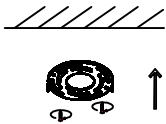

Install the hanging plate on the ceiling

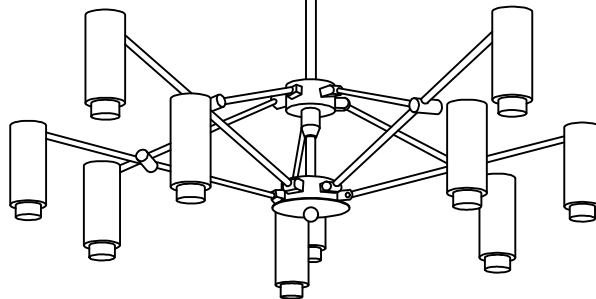

Install the lamp body on the hanging plate