

1

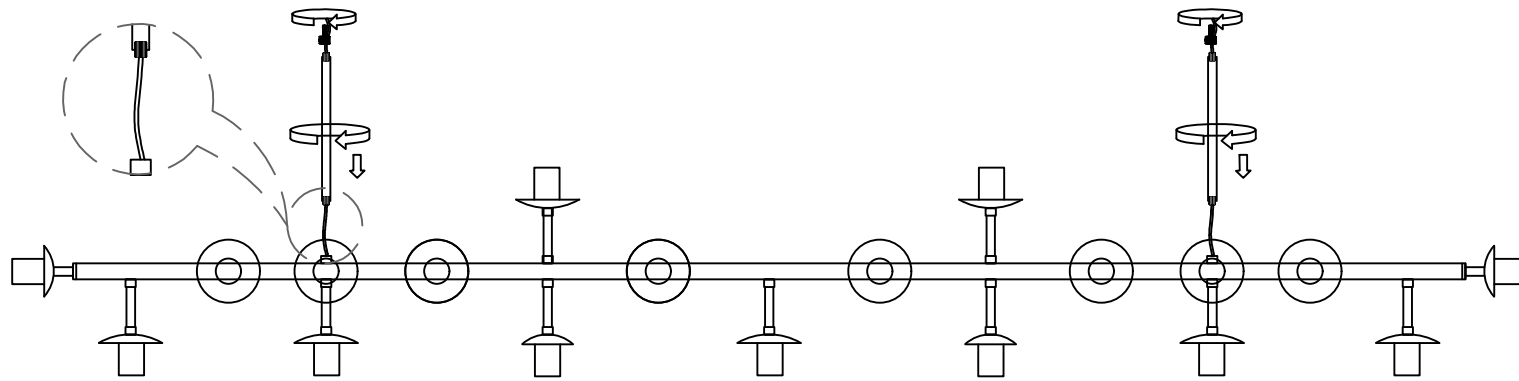

Twist the suspension rod into the lamp body

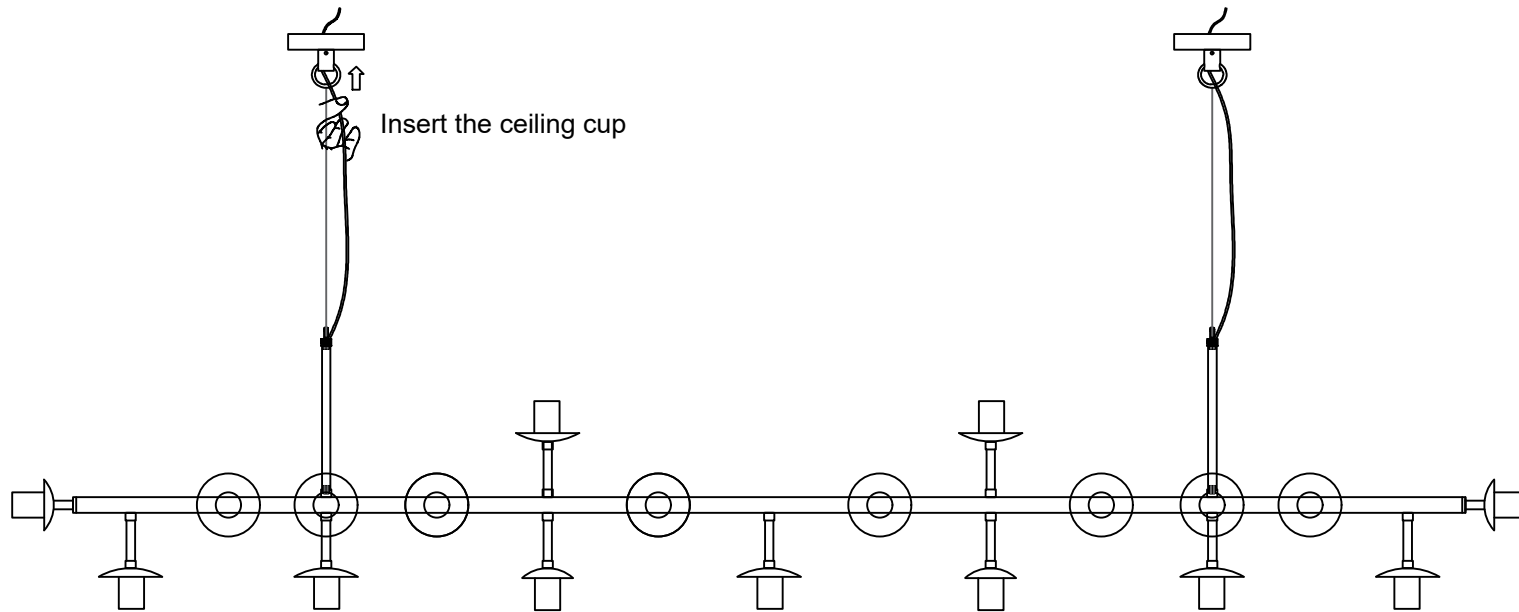

Insert the ceiling cup

# 2

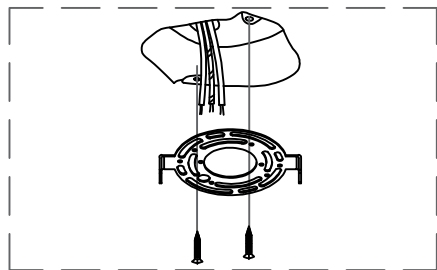

Fasten the hanging board to the ceiling with screws

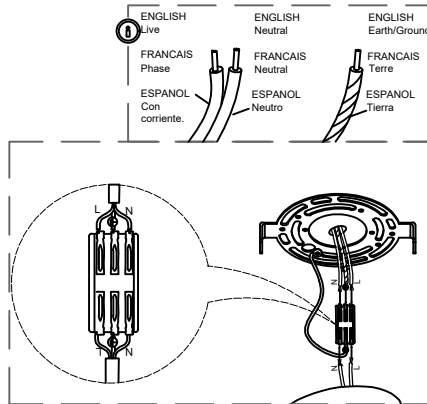

The wires in the home are connected to the wires in the lamps through the wire terminals

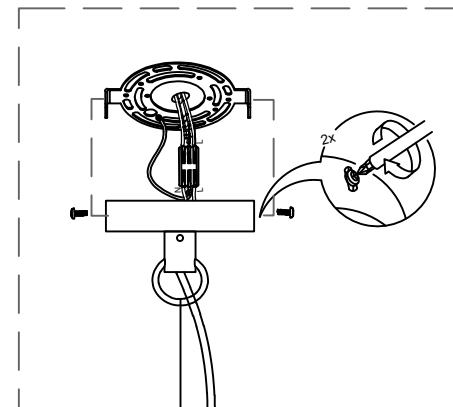

The side screws fix the lamp body to the ceiling plate

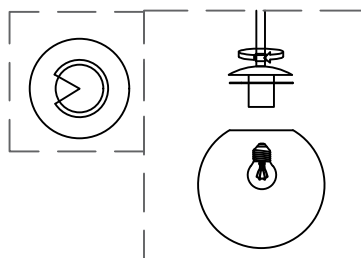
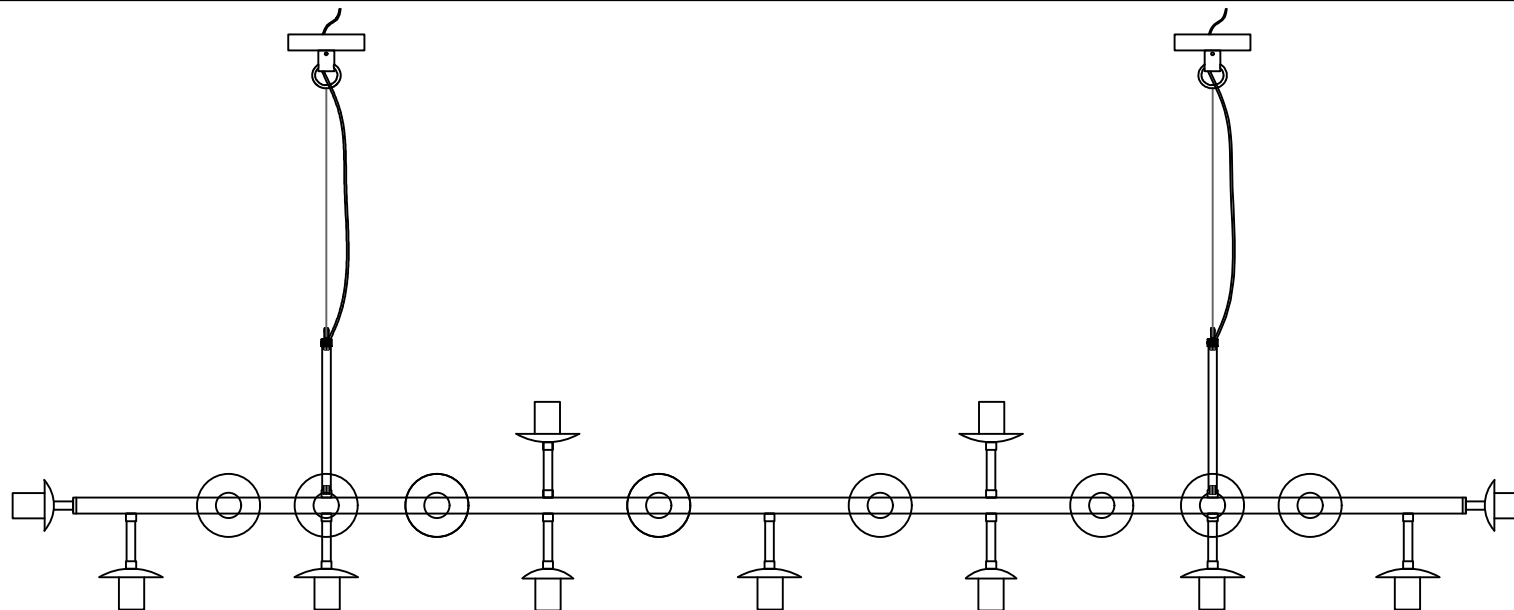

Installing light source and lampshade